

SERIES: AE10-EW-DIN | DESCRIPTION: DC-DC CONVERTER
FEATURES

- 10 watts
- high operating temp -40 to +70°C
- 4,000 Vac isolation
- extra wide input voltage 10:1
- input voltage up to 1 kVdc
- OVP protection
- output short circuit protection
- DIN-rail mounted
- EN 62109 approved

**MODEL**

MODEL	input voltage range (Vdc)	output voltage (Vdc)	output current		output power max (W)	ripple & noise ¹ max (mVp-p)	efficiency ² typ (%)
			min (A)	max (A)			
AE10-EW-S5-DIN	100~1000	5	0	2.00	10	200	72
AE10-EW-S9-DIN	100~1000	9	0	1.11	10	200	76
AE10-EW-S24-DIN	100~1000	24	0	0.42	10	200	80

Notes: 1. Measured at nominal input, 20 MHz bandwidth oscilloscope, with 10 μ F electrolytic and 1 μ F ceramic capacitors on the output.
 2. Measured at 200 Vdc input voltage, full load.
 3. All specifications are measured at Ta=25°C, humidity < 75%, nominal input voltage, and rated output load unless otherwise specified.

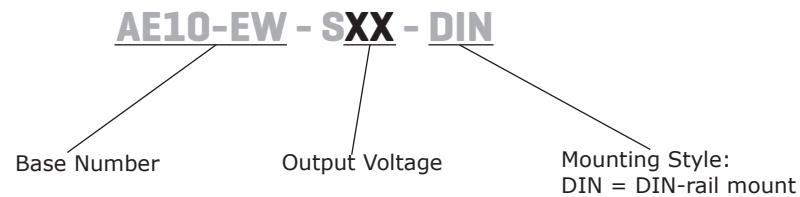
PART NUMBER KEY

INPUT

parameter	conditions/description	min	typ	max	units
operating input voltage		100		1000	Vdc
current	at 200 Vdc at 600 Vdc at 1000 Vdc			75 25 16	mA mA mA
inrush current	at 200 Vdc at 600 Vdc at 1000 Vdc		7 20 30		A A A
input fuse	1 A / 1000 Vdc (external)				

OUTPUT

parameter	conditions/description	min	typ	max	units
maximum capacitive load	5 Vdc output model 9 Vdc output model 24 Vdc output model			6,000 4,000 470	μ F μ F μ F
voltage accuracy			± 1	± 2	%
line regulation	from low line to high line, full load		± 0.5	± 1	%
load regulation	from 0% to full load		± 0.5	± 1	%
delay time	from $V_{in} = 0$ V to 90% of rated output voltage			1	s
switching frequency				75	kHz
temperature coefficient	at full load		± 0.02		%/°C

PROTECTIONS

parameter	conditions/description	min	typ	max	units
over voltage protection	5 Vdc output model 9 Vdc output model 24 Vdc output model			7.5 12 28	Vdc Vdc Vdc
over current protection	automatic recovery	110			%
short circuit protection	continuous, automatic recovery				

SAFETY AND COMPLIANCE

parameter	conditions/description	min	typ	max	units
isolation voltage	input to output for 1 minute	4,000			Vac
safety approvals	EN 62109				
conducted emissions	CISPR22/EN55022, class A (external circuit required, see Figure 2)				
radiated emissions	CISPR22/EN55022, class A (external circuit required, see Figure 2)				
ESD	IEC/EN61000-4-2, contact ± 6 kV/air ± 8 kV, class B				
radiated immunity	IEC/EN61000-4-3, 10V/m, class A				
EFT/burst	IEC/EN61000-4-4, ± 4 kV, class B (external circuit required, see Figure 2)				
surge	IEC/EN61000-4-5, ± 2 kV, class B (external circuit required, see Figure 2)				
conducted immunity	IEC/EN61000-4-6, 10 Vr.m.s, class A				
MTBF	as per MIL-HDBK-217F, 25°C	300,000			hours
RoHS	2011/65/EU				

ENVIRONMENTAL

parameter	conditions/description	min	typ	max	units
operating temperature	see derating curves	-40		70	°C
storage temperature		-40		105	°C
storage humidity	non-condensing			95	%
altitude				2000	m

MECHANICAL

parameter	conditions/description	min	typ	max	units
dimensions	96.10 x 54.00 x 36.60 [3.783 x 2.126 x 1.441 inch]				mm
case material	black flame-retardant heat-proof plastic (UL94V-0)				
weight			190		g

MECHANICAL DRAWING

units: mm [inch]
tolerance: ±0.50[±0.020]

installed on DIN rail TS35
wire range: 24~12 AWG
tightening torque: max 0.4 N*m

PIN CONNECTIONS	
PIN	Function
1	-Vin
2	NC
3	+Vin
4	+Vout
5	NC
6	NC
7	-Vout

NC=no connection

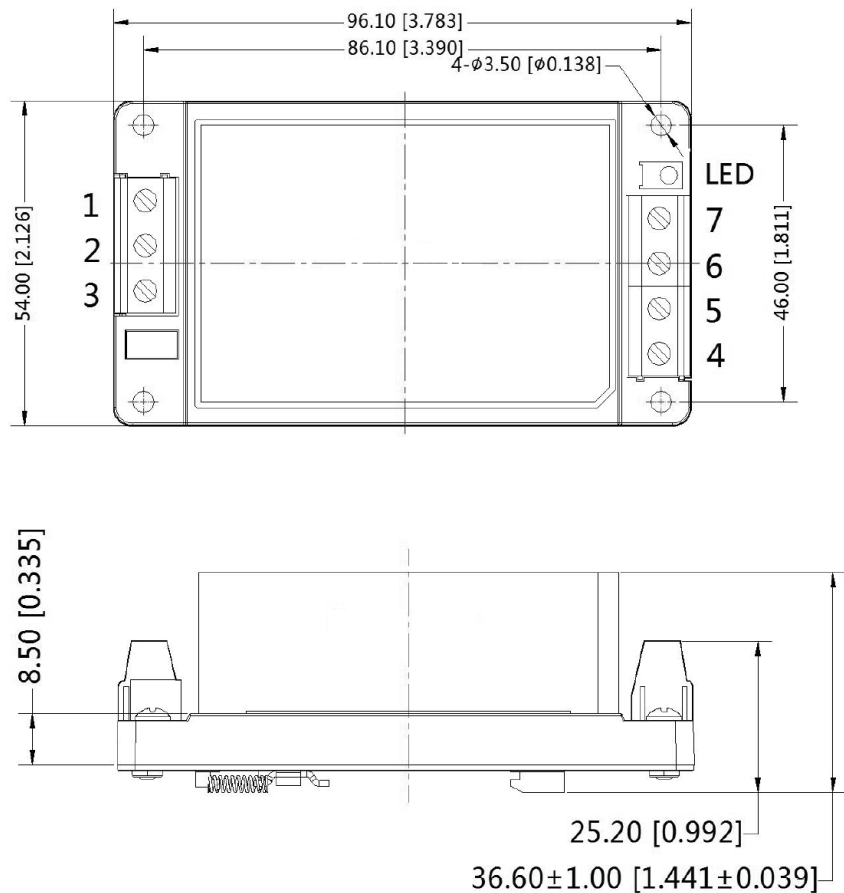

DERATING CURVES

**TEMPERATURE DERATING CURVE
(100~150 Vdc Input voltage)**

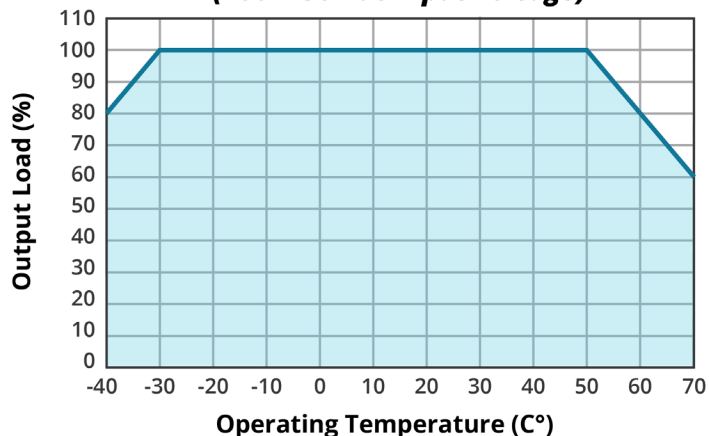

**TEMPERATURE DERATING CURVE
(150~1000 Vdc Input voltage)**

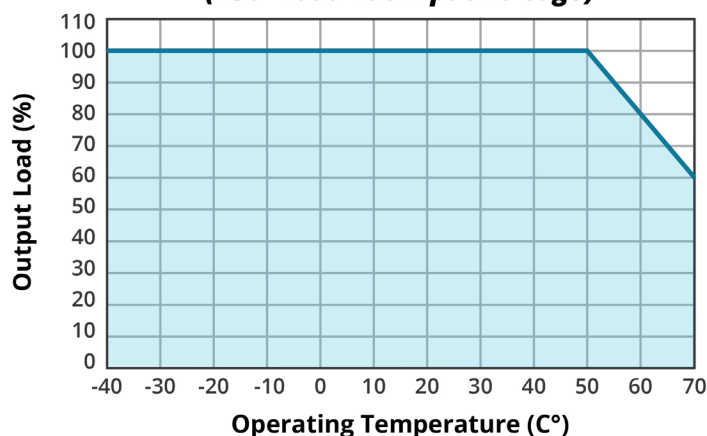

**INPUT VOLTAGE DERATING CURVE
25°C**

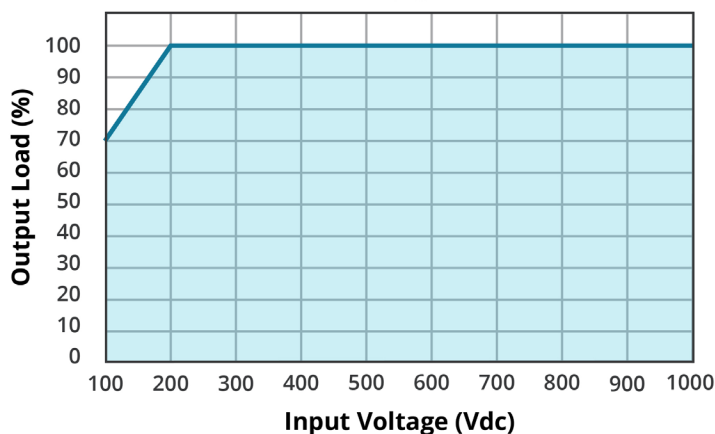

EFFICIENCY CURVES

**EFFICIENCY VS INPUT VOLTAGE
AE10-EW-S5-DIN**

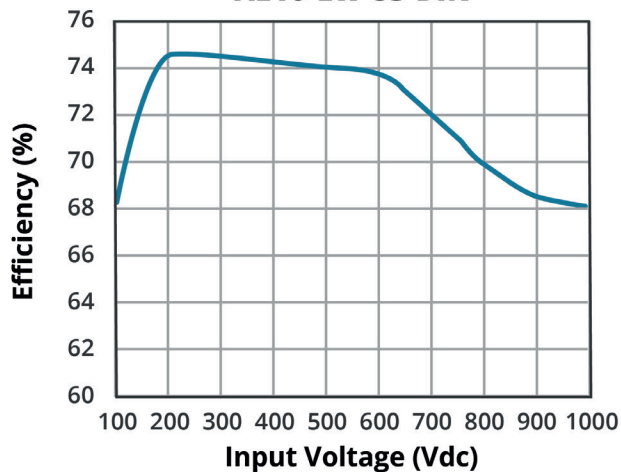

**EFFICIENCY VS OUTPUT LOAD
AE10-EW-S5-DIN**

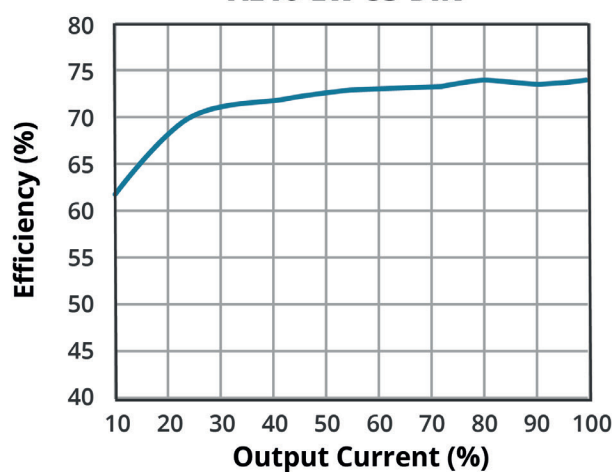

EFFICIENCY CURVES (CONTINUED)

**EFFICIENCY VS INPUT VOLTAGE
AE10-EW-S9-DIN**

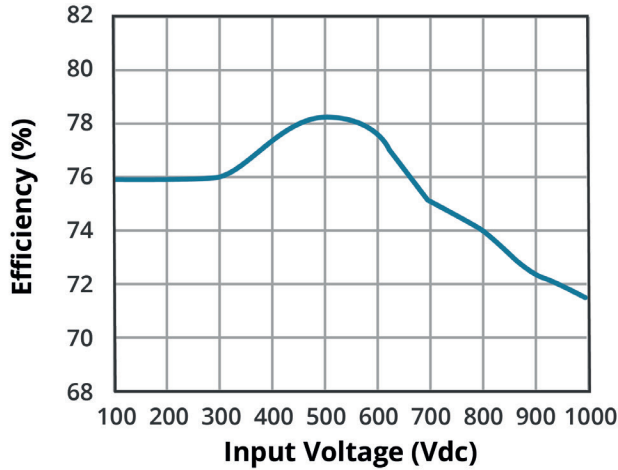

**EFFICIENCY VS OUTPUT LOAD
AE10-EW-S9-DIN**

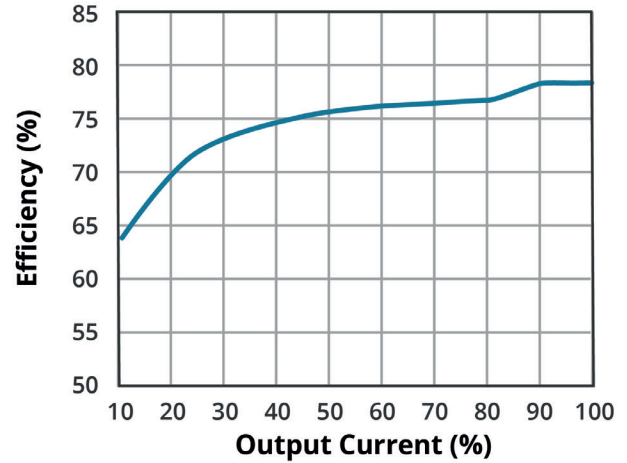

**EFFICIENCY VS INPUT VOLTAGE
AE10-EW-S24-DIN**

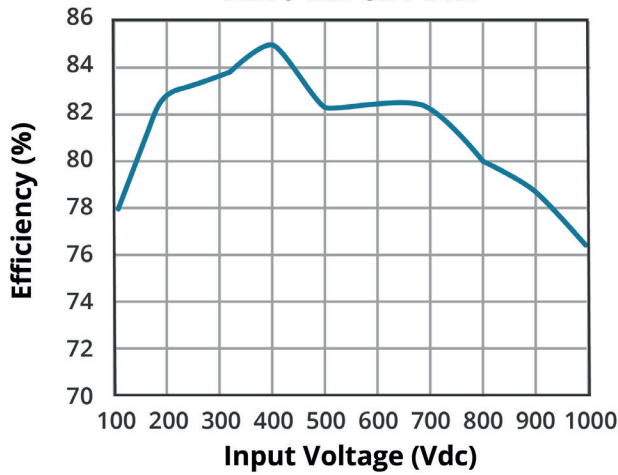

**EFFICIENCY VS OUTPUT LOAD
AE10-EW-S24-DIN**

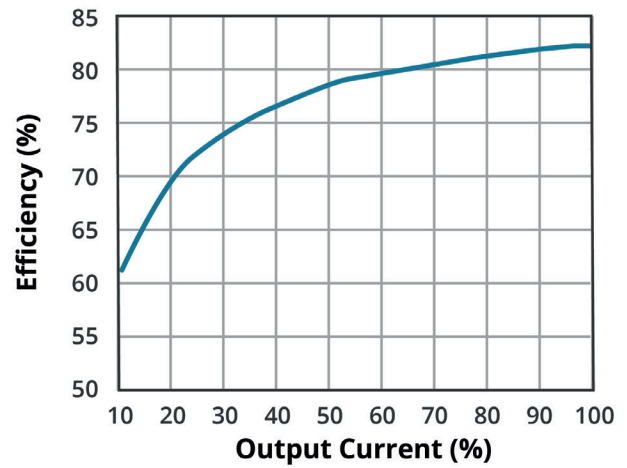

APPLICATION CIRCUIT

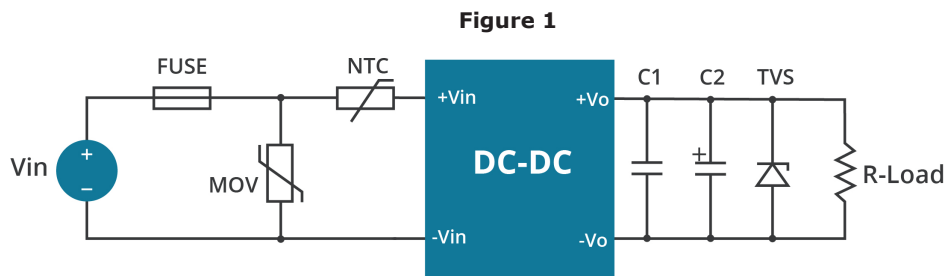

Table 1

Vout (Vdc)	Fuse	MOV	NTC	C1 (μF)	C2 (μF)	TVS
5	1 A / 1000 Vdc	S14K880	10D-11	1	220	SMBJ7.0A
9	1 A / 1000 Vdc	S14K880	10D-11	1	120	SMBJ12A
24	1 A / 1000 Vdc	S14K880	10D-11	1	68	SMBJ33A

EMC RECOMMENDED CIRCUIT

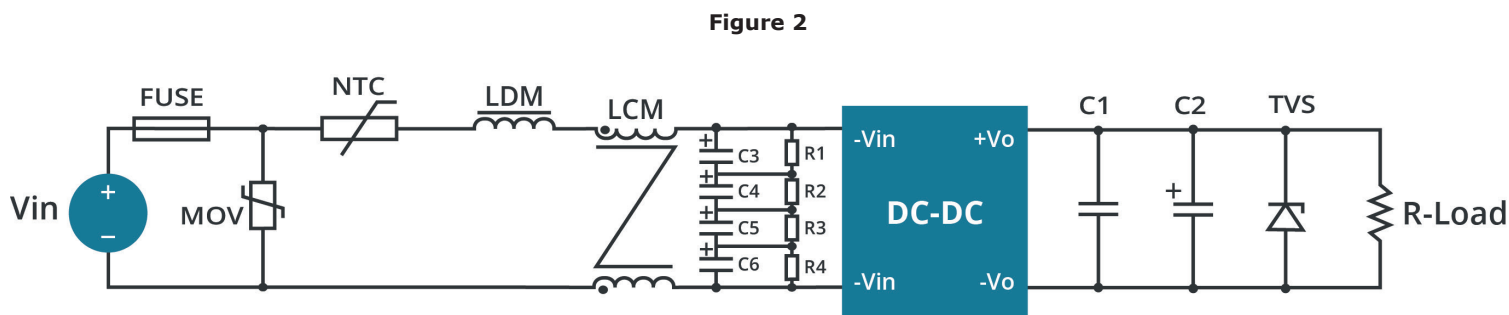

Table 2

Recommended External Circuit Components	
FUSE	1 A/1000 Vdc
MOV	S14K880
C3, C4, C5, C6	47 μF/400 Vdc
R1, R2, R3, R4	1 MΩ/2 W
NTC	10D-11
LDM	4.7 mH/0.38 A
LCM	10 mH

Note: See also Table 1.

Notes: 1. C1 is a ceramic capacitor used to filter high frequency noise.
 2. C2 is electrolytic and is recommended to be high frequency and low resistance. For capacitance and current of the capacitor, refer to the datasheet provided by the manufacturer. Capacitance withstand voltage derating should be 80% or above.

REVISION HISTORY

rev.	description	date
1.0	initial release	09/13/2017
1.01	company logo updated	04/12/2021
1.02	derating curve, efficiency curves and circuit figures updated	07/28/2021

The revision history provided is for informational purposes only and is believed to be accurate.



CUI INC
a bel group

Headquarters
20050 SW 112th Ave.
Tualatin, OR 97062
800.275.4899

Fax 503.612.2383
cui.com
techsupport@cui.com

CUI offers a two (2) year limited warranty. Complete warranty information is listed on our website.

CUI reserves the right to make changes to the product at any time without notice. Information provided by CUI is believed to be accurate and reliable. However, no responsibility is assumed by CUI for its use, nor for any infringements of patents or other rights of third parties which may result from its use.

CUI products are not authorized or warranted for use as critical components in equipment that requires an extremely high level of reliability. A critical component is any component of a life support device or system whose failure to perform can be reasonably expected to cause the failure of the life support device or system, or to affect its safety or effectiveness.